

Sieci komputerowe

Mikołaj Czechlewski

20.01.2022



- 1 Model warstwowy sieci

Plan wykładu 12 (powtórka)

- 1 Model warstwowy sieci
- 2 Warstwa 7

Plan wykładu 12 (powtórka)

- 1 Model warstwowy sieci
- 2 Warstwa 7
- 3 Warstwa 4

Plan wykładu 12 (powtórka)

- 1 Model warstwowy sieci
- 2 Warstwa 7
- 3 Warstwa 4
- 4 Warstwa 3

Plan wykładu 12 (powtórka)

- 1 Model warstwowy sieci
- 2 Warstwa 7
- 3 Warstwa 4
- 4 Warstwa 3
- 5 Warstwa 2

Plan wykładu 12 (powtórka)

- 1 Model warstwowy sieci
- 2 Warstwa 7
- 3 Warstwa 4
- 4 Warstwa 3
- 5 Warstwa 2
- 6 Warstwa 1

Model warstwowy sieci

OSI



TCP/IP



Model warstwowy sieci

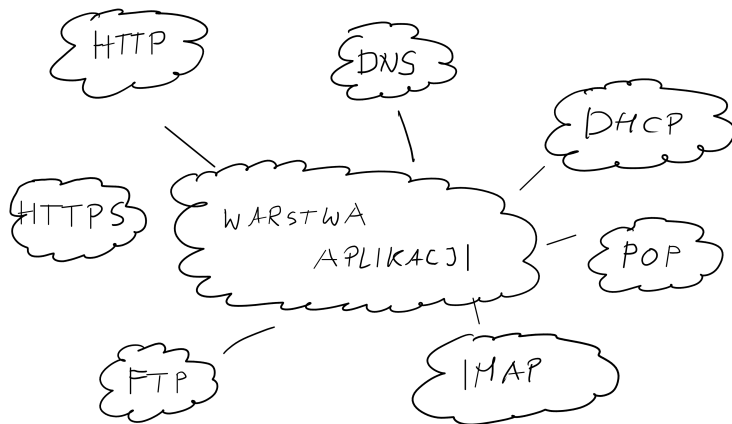

Model warstwowy sieci

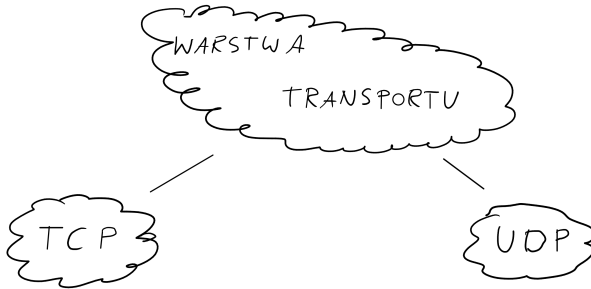

Model warstwowy sieci

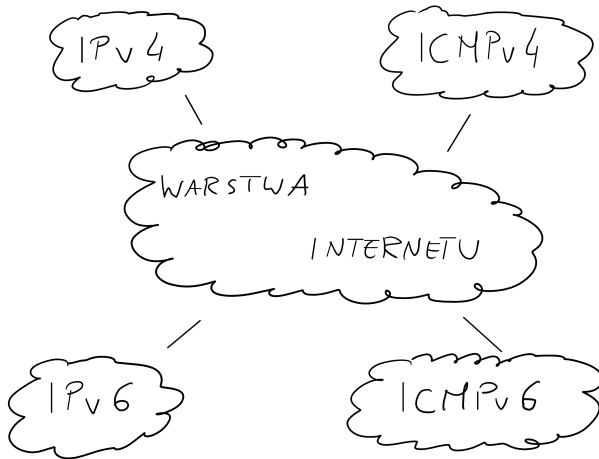

Model warstwowy sieci



Model warstwowy sieci

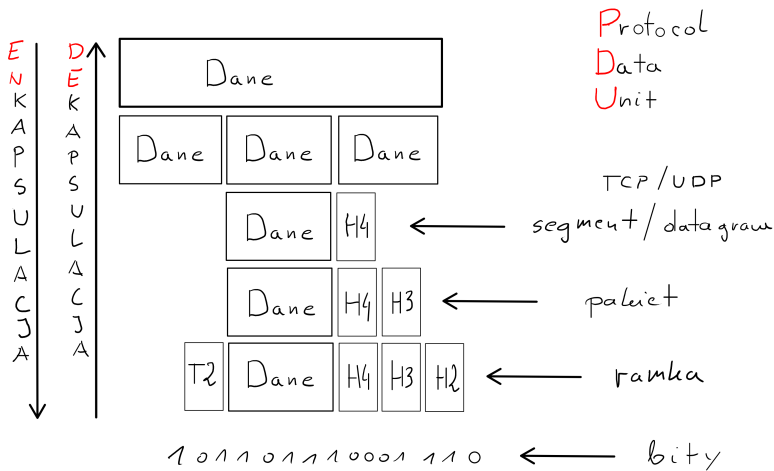

Model warstwowy sieci

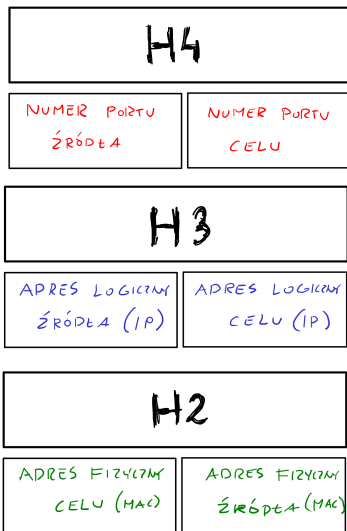

Warstwa 7

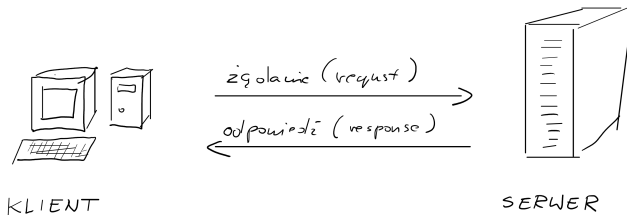

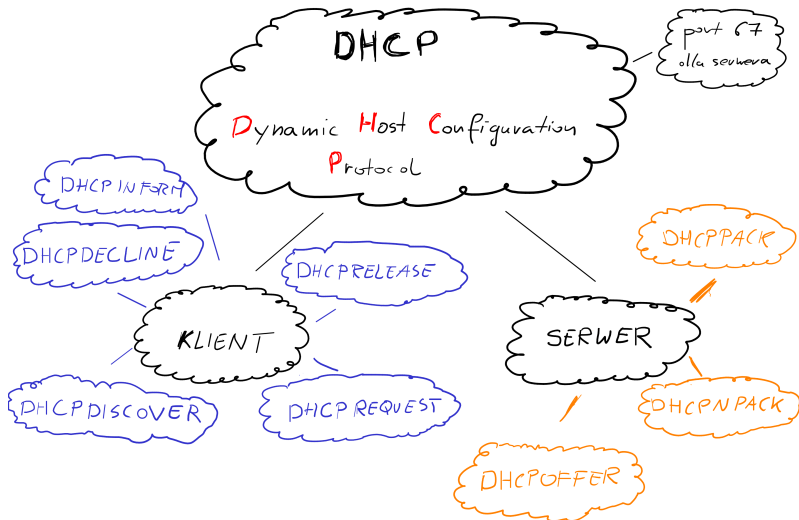

Warstwa 7



KLIENT
DHCP



SERWER
DHCP

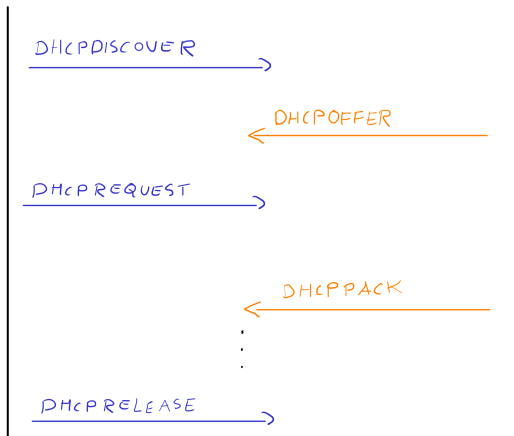

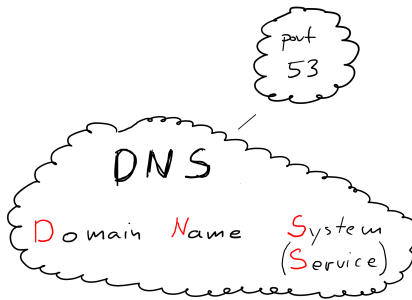

Warstwa 7

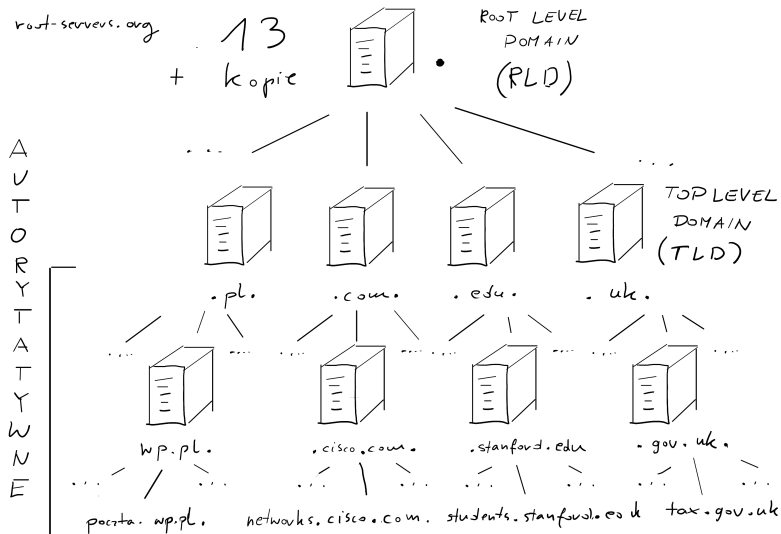

Warstwa 7

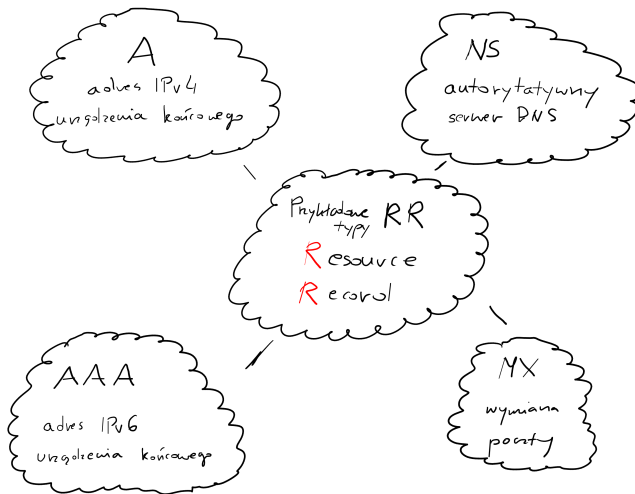

Warstwa 7

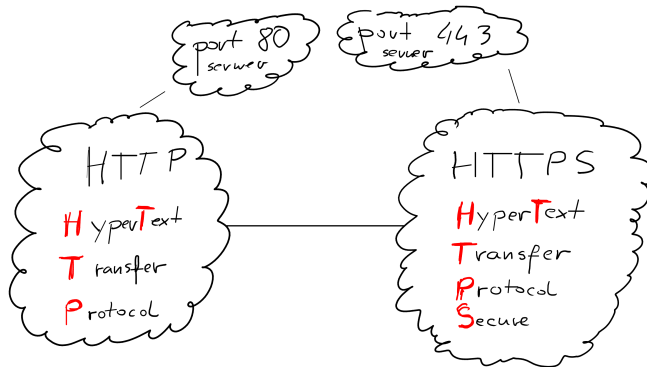

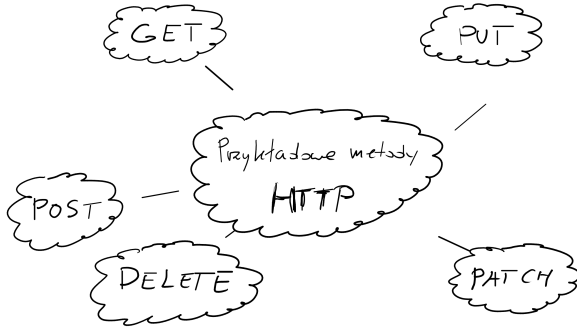

Warstwa 7

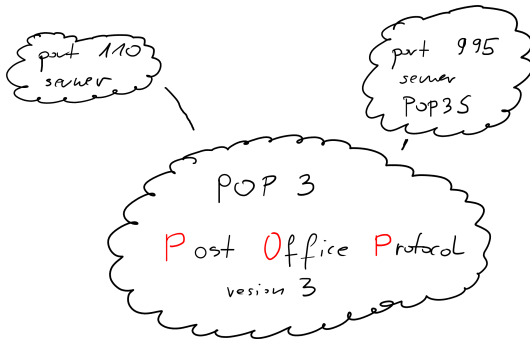

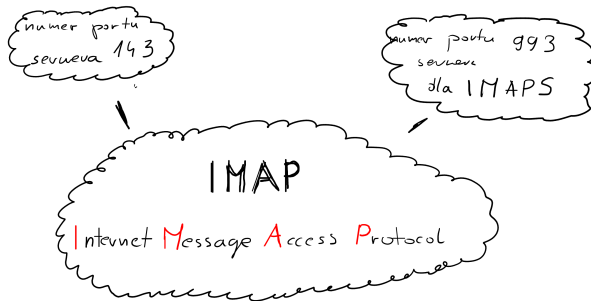

Warstwa 7

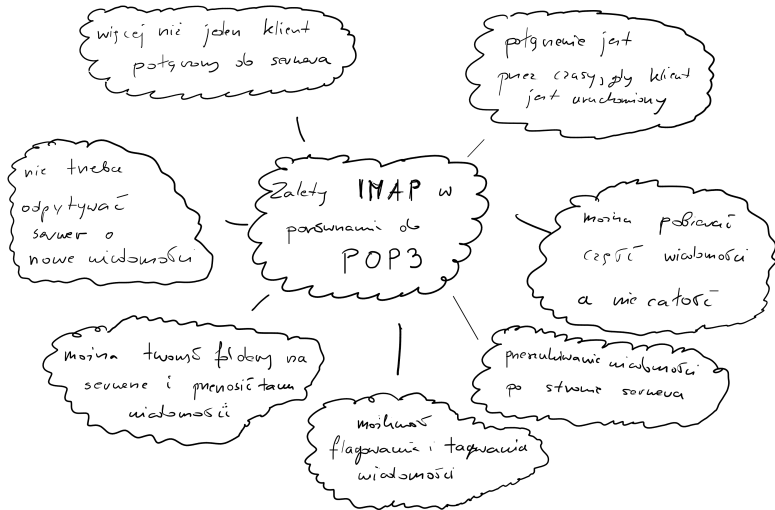

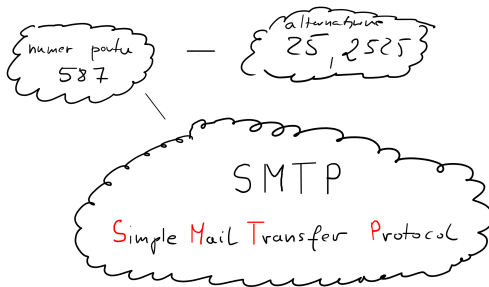

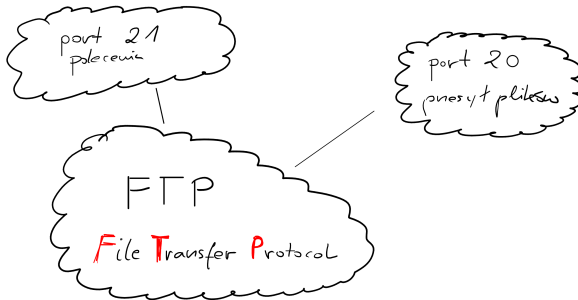

Warstwa 7



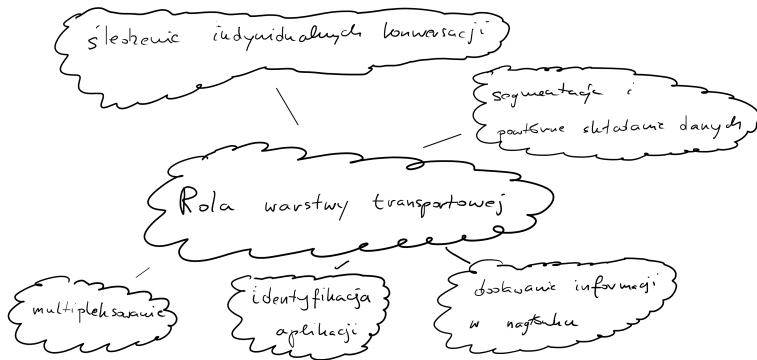

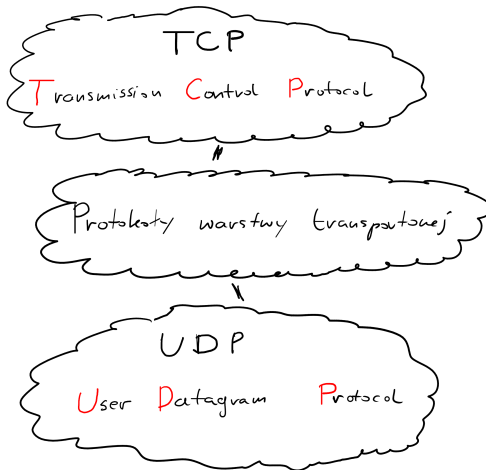

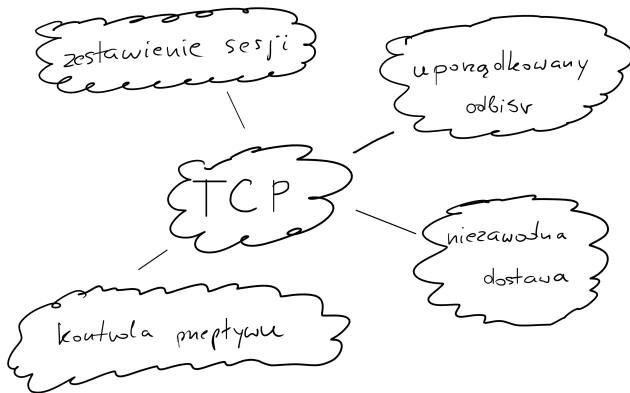

Warstwa 4

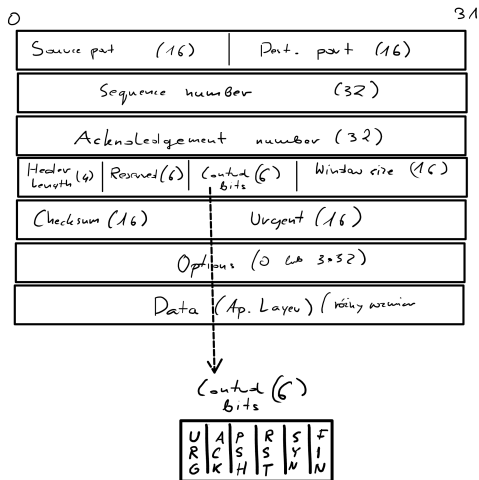

NAGŁÓWEK TCP

Warstwa 4

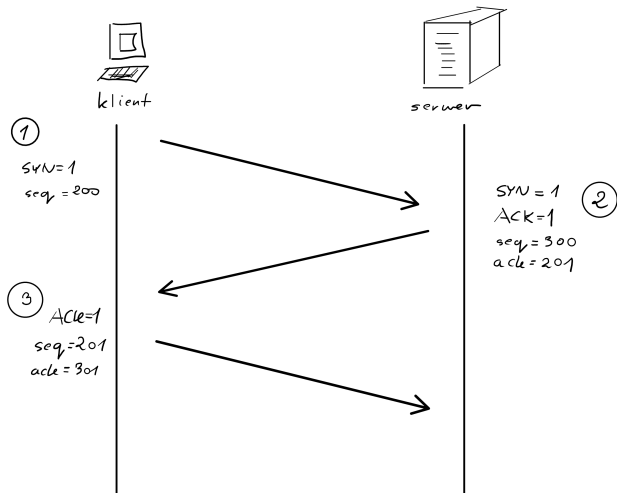

UZGÓDNIANIE TRÓJETAPOWE

Warstwa 4

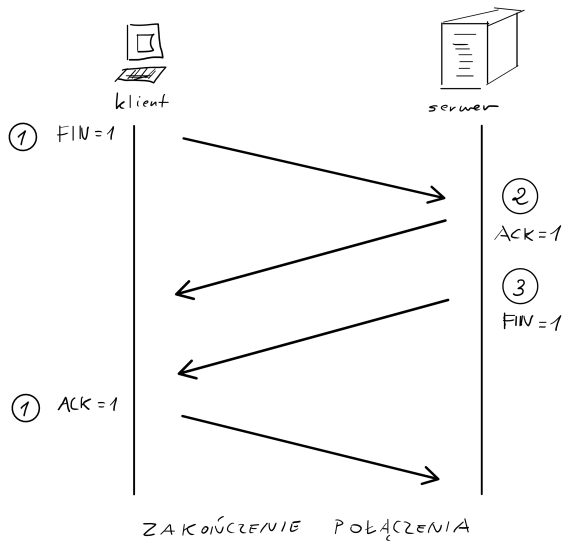

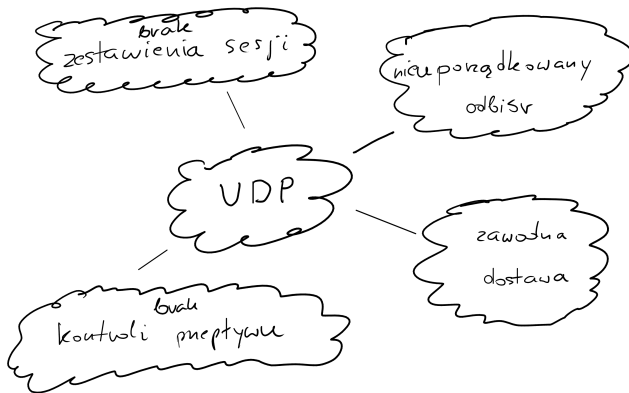

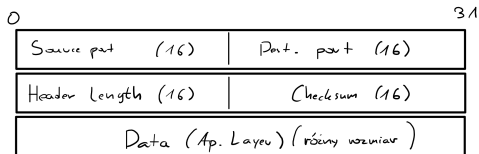

NAGŁÓWEK UDP

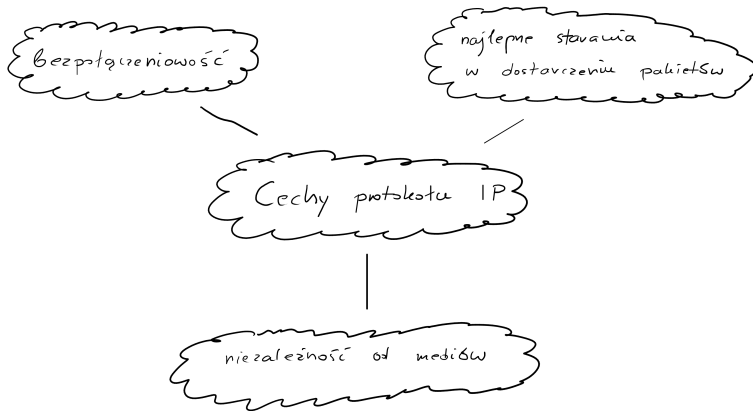

Warstwa 3

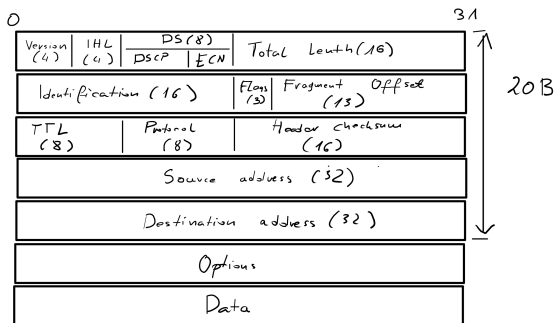

NAGŁÓWEK IPv4

Warstwa 3

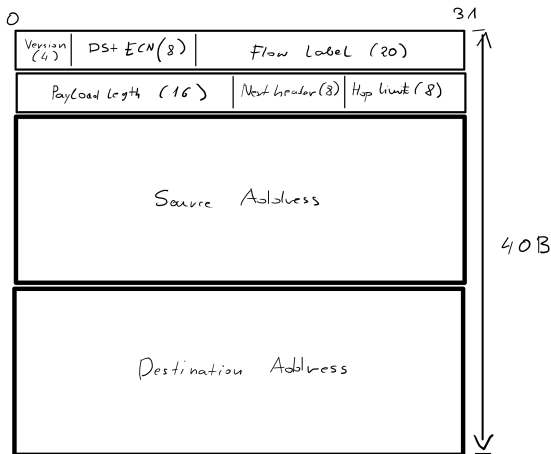

NAGŁÓWEK IPv6

Warstwa 3

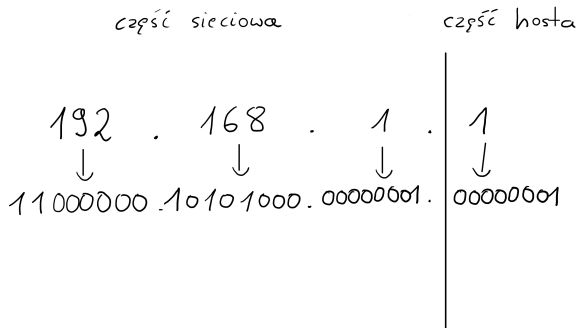

STRUKTURA ADRESU IPv4

Warstwa 3

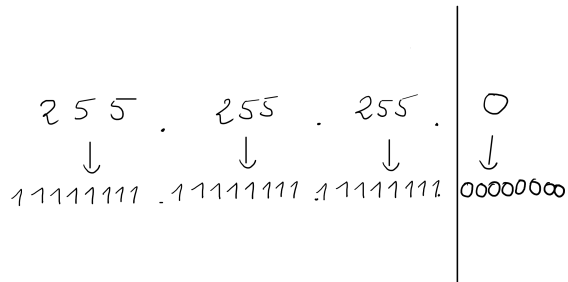

dlugość prefiksu /24

MASKA PODSIECI

Warstwa 3

AND

0	1	0
1	0	0
0	0	0
1	1	1

ADRES SIECI

192 . 168 . 1 . 1

adres
hosta

11000000 . 10101000 . 00000001 . 00000001

AND

255 . 255 . 255 . 0

maska
podsieci

11111111 . 11111111 . 11111111 . 00000000

AND

11000000 . 10101000 . 00000001 . 00000001

11111111 . 11111111 . 11111111 . 00000000

11000000 . 10101000 . 00000001 . 00000000

192 . 168 . 1 . 0

adres
sieci

ADRESY HOSTÓW

192 . 168 . 1 . 1

do

192 . 168 . 1 . 254

ADRES ROZGŁOSZENIOWY

192 . 168 . 1 . 255

Warstwa 3

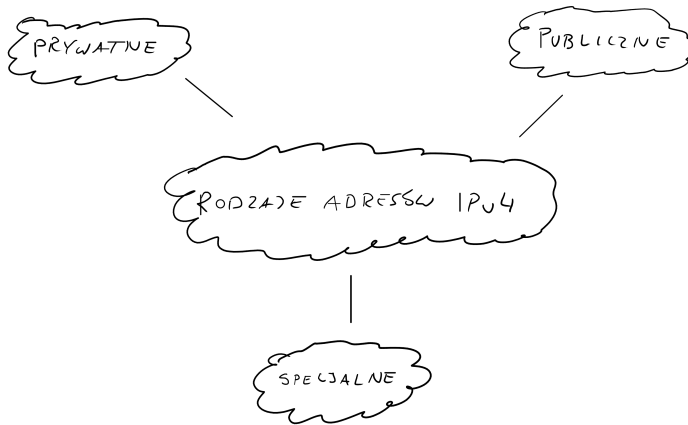

PRYWATNE ADRESY IPv4 (RFC 1918)

10.0.0.0 / 8

10.0.0.0 - 10.255.255.255

172.16.0.0 / 12

172.16.0.0 - 172.31.255.255

192.168.0.0 / 16

192.168.0.0 - 192.168.255.255

Warstwa 3

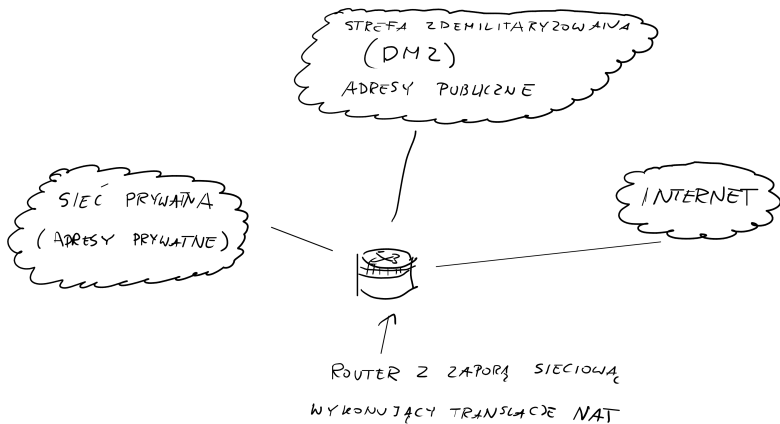

SPECJALNE ADRESY IPv4

PĘTLI ZWROTNEJ

127.0.0.0/8

127.0.0.1 - 127.255.255.254

LINK-LOCAL

169.254.0.0/16

169.254.0.1 - 169.254.255.254

Warstwa 3

H: H: H: H: H: H: H: H

0000 - ffff

0000000000000000 - 1111111111111111

Warstwa 3

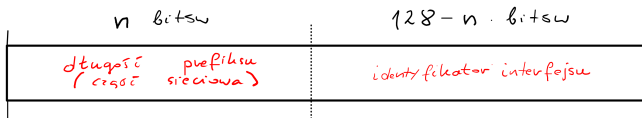

Rekomendowane $n = 64$

/64

Warstwa 3

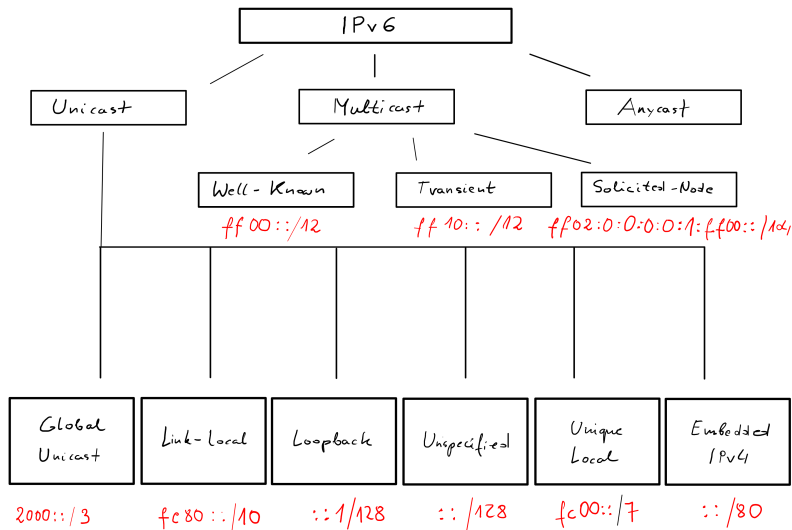

Global Unicast Address (GUA)

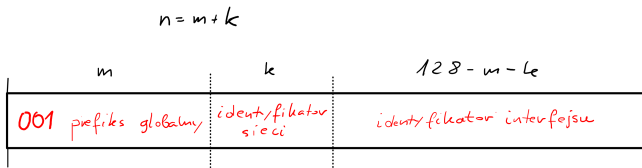

`2000::/3`

Link-Local Unicast Address (LLA)

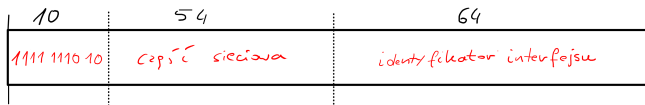

$fe80::/10$

Unique Local Address
(ULA)

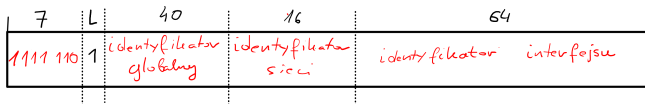

fc00::/7

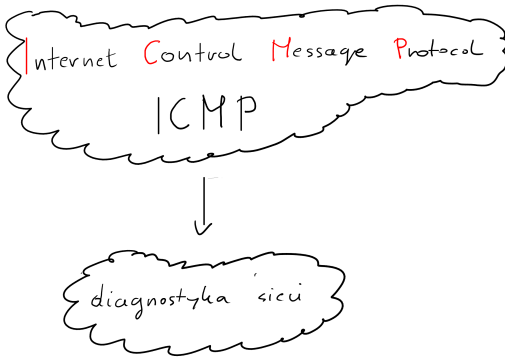

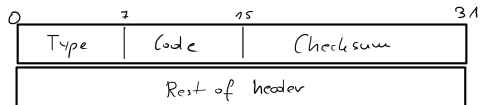

NAGŁÓWEK ICMP

Warstwa 2

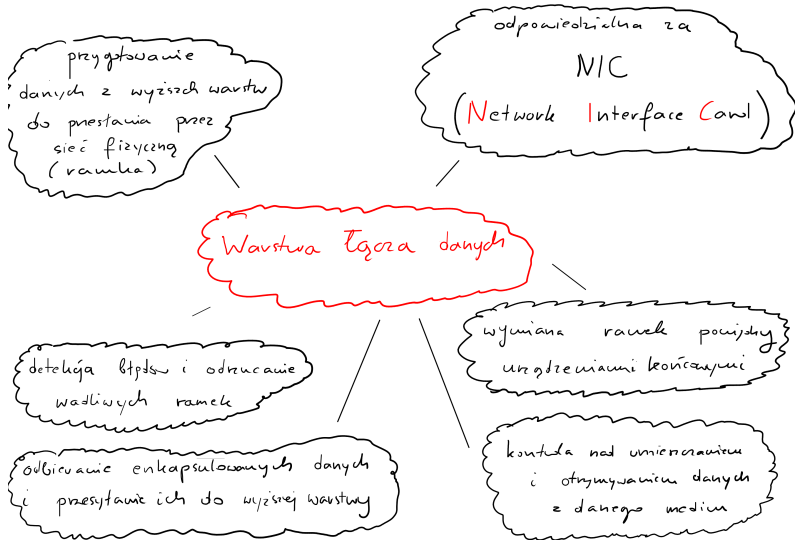

Warstwa 2

Warstwa sieci	Protokoły warstwy sieci			
Warstwa Łączna danych	Podwarstwa LLC Logical Link Control	LLC IEEE 802.2		
	Podwarstwa MAC Media Access Control	Ethernet IEEE 802.3	WLAN IEEE 802.11	WPAN IEEE 802.15
Warstwa fizyczna		Standardy Ethernet	Standardy WLAN	Standardy WPAN: IrDA, Bluetooth i tp

Warstwa 2

Komunikuje się pomiędzy oprogramowaniem sieciowym
a urządzeniami z niższej warstwy

LLC

Wstawia w ramkę informacje o protokole warstwy 3
(IPv4, IPv6)

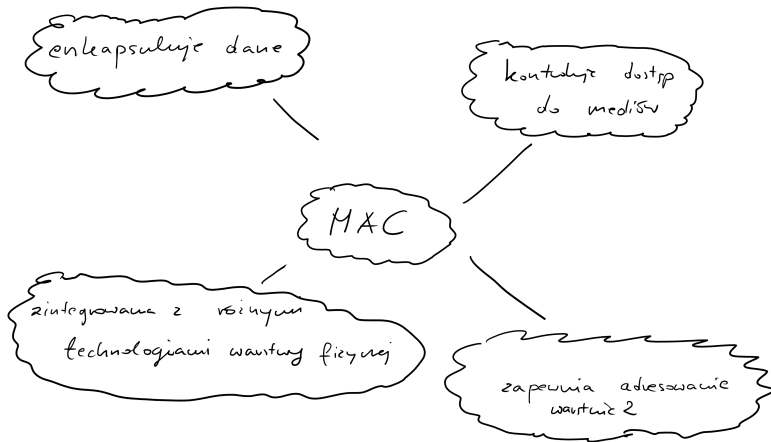

Warstwa 2

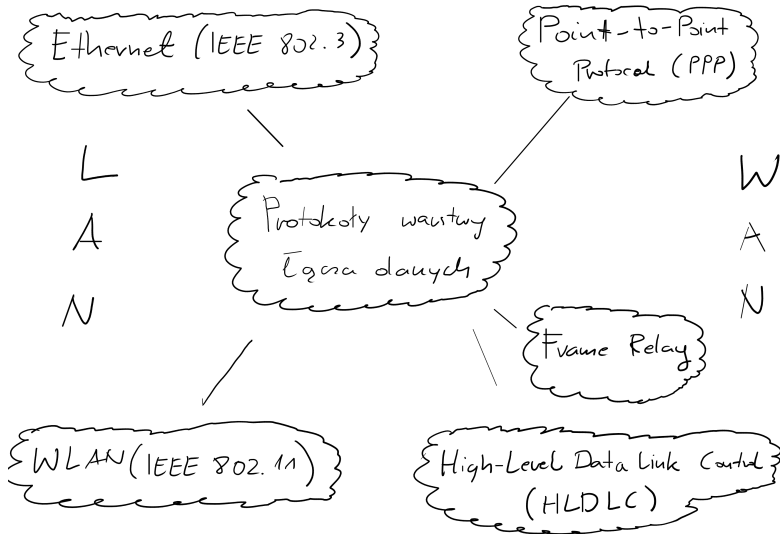

Struktura ramki

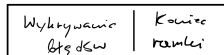
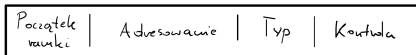

Struktura adresu MAC

48 bitów = 6 bajtów

00-60-2F-3A-07-BC

OUI

Organizationally

Unique

Identifier

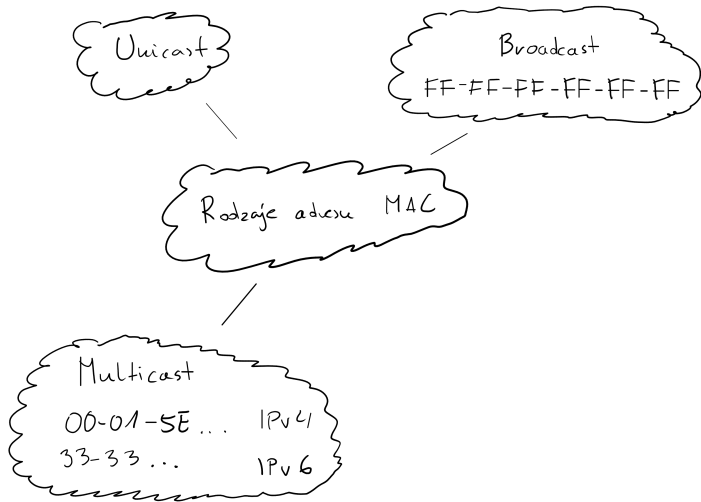

Ramka Ethernet

PRE + SFD (8)	Docelowy MAC (6)	Źródłowy MAC (6)	Typ / Protokół (2)	Dane (46 - 1500)	FCS (4)
------------------	---------------------	---------------------	-----------------------	---------------------	------------

PRE - preambula

SFD - start of frame delimiter

FCS - frame check sequence

Adres IPv4 jest w tabeli ?



Mam wpis w tabeli MAC ?

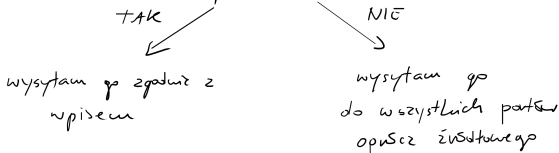

Warstwa 2

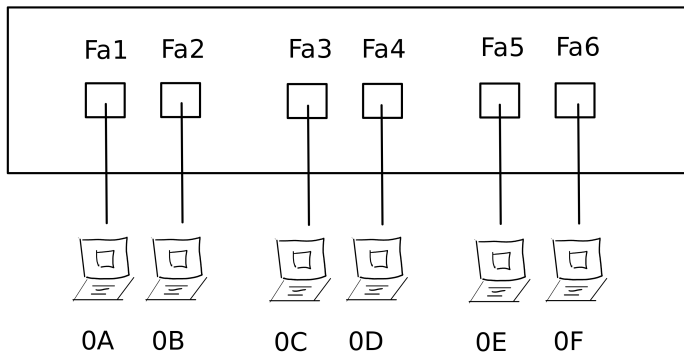

Warstwa 2

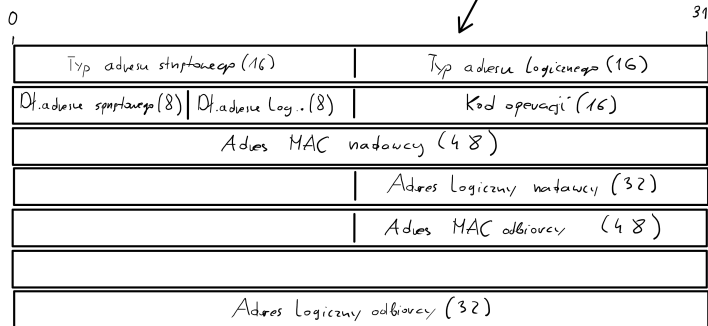
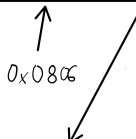
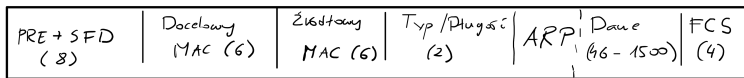

Warstwa 2

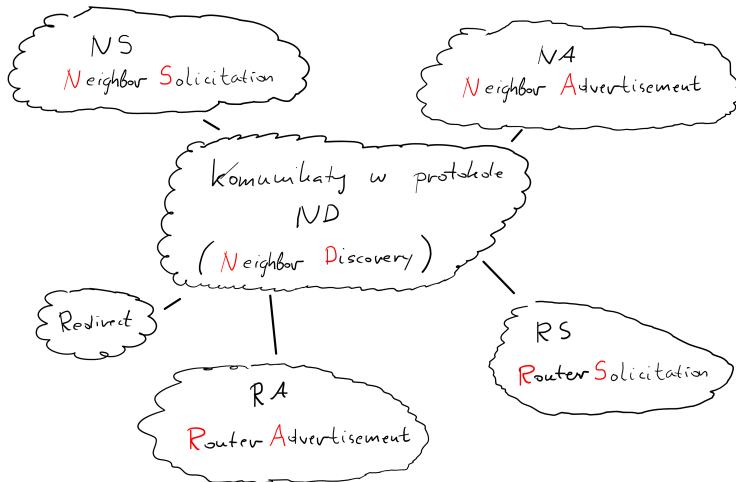

Warstwa 1

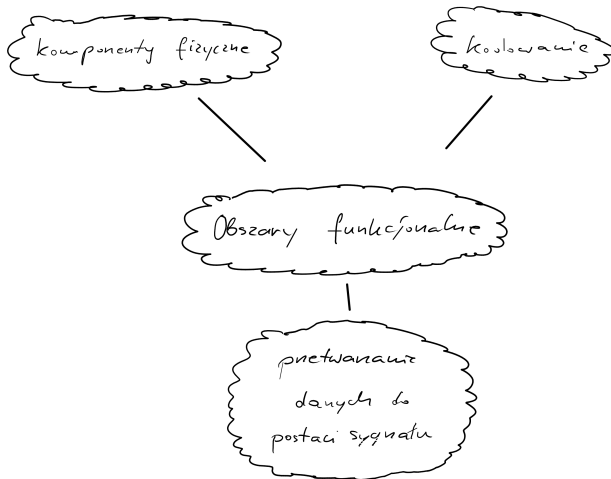

Warstwa 1

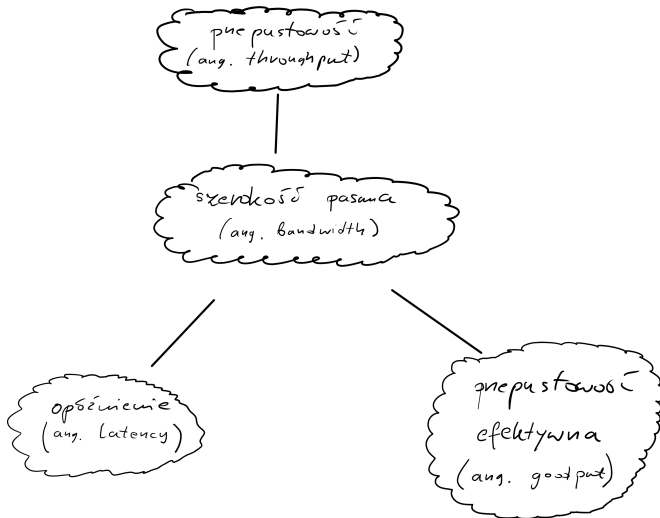

Warstwa 1

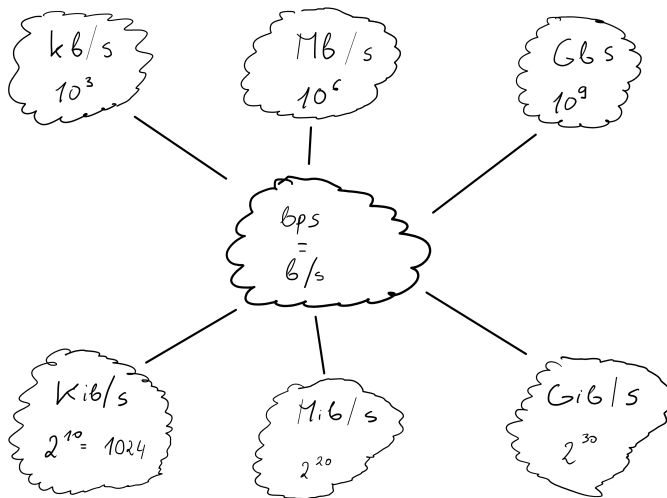

Warstwa 1

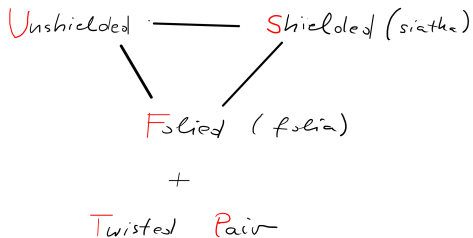

X/YTP

$X = \{U, S, F, SF\}$

$Y = \{U, F\}$

Warstwa 1

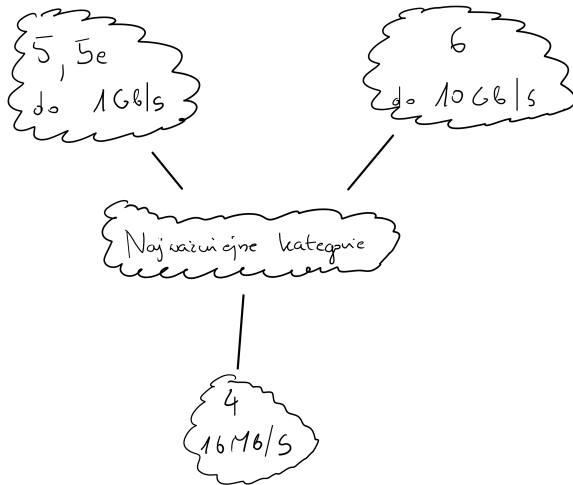

Warstwa 1

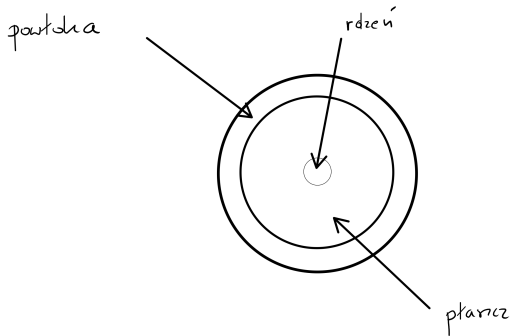



Warstwa 1

